

GLIM MINI SUSPENSION

D81040

GENERAL

Series: Glim Mini

Brand: Panzeri

Division: Design

Mounting Type: Suspension

Mounting Location: Ceiling

Subcategory: Pendant

PHYSICAL

Shape: Abstract

Length (mm): 170

Length (in): 6 ³/₄

Height (mm): 760

Height (in): 30

Light Distribution: Omnidirectional

Weight (kg): 1.4

Weight (lbs): 3

Diffuser: Matte White Printed Pyrex

Fixture Finish: Chrome

Fixture Material: Metal

ELECTRICAL

Number of Lamps: 1

Lamp Type: LED Retrofit

Lamp Shape: T4

Bulb Included: Bulb Not Included

Total Output Wattage (W): 3

Max. Wattage Per Lamp (W): 3

Lamp Base: G9

Input Voltage (V): 120

LED

OPTICAL

RATINGS AND CERTIFICATIONS

Certified By: CSA Certified to UL and CSA Standards

IP rating: IP40

PROJECT

TYPE

NOTES

QUANTITY

DATE

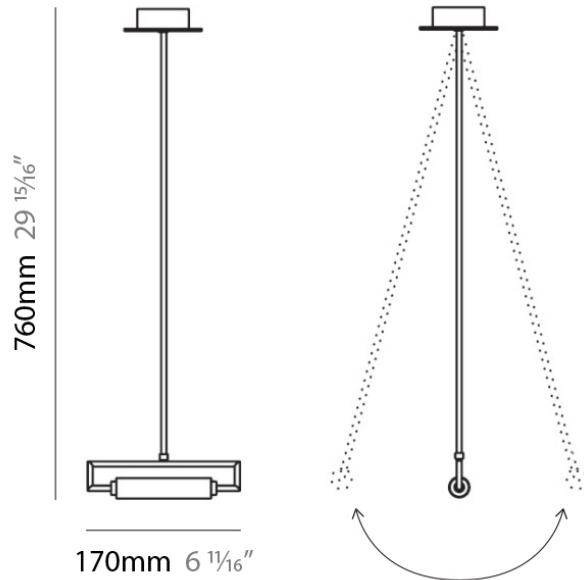

GLIM MINI SURFACE

D83038

PROJECT _____

TYPE _____

NOTES _____

QUANTITY _____

DATE _____

GENERAL

Series: Glim Mini

Brand: Panzeri

Division: Design

Mounting Type: Surface

Mounting Location: Wall

Subcategory: Ambient

PHYSICAL

Shape: Abstract

Length (mm): 280

Length (in): 11

Height (mm): 200

Height (in): 7 ³/₄

Extension (mm): 170

Extension (in): 6 ³/₄

Light Distribution: Omnidirectional

Weight (kg): 1.23

Weight (lbs): 2.7

Diffuser: Matte White Printed Pyrex

Fixture Finish: Metallic Gray

Fixture Material: Metal

ELECTRICAL

Number of Lamps: 1

Lamp Type: LED Retrofit

Lamp Shape: T3

Bulb Included: Bulb Not Included

Total Output Wattage (W): 20

Max. Wattage Per Lamp (W): 20

Lamp Base: RSC

Input Voltage (V): 120

LED

OPTICAL

RATINGS AND CERTIFICATIONS

Certified By: CSA Certified to UL and CSA Standards

IP rating: IP40



200mm 7 ⁷/₈"

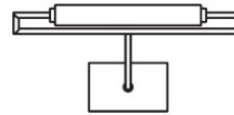



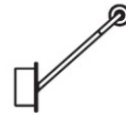

































































280mm 11"



170mm 6 ¹/₁₆"

LEGEND

| | | | | | |
|--|---|---|--|---|--|
|  | floor-mounted |  | pivotable |  | special LED (upon request) RGB, RGBW, tunable, gold+, meat+, art+, fashion+ |
|  | wall and ceiling: recessed and surface mounted |  | rotating |  | warm dim / natural dimming LED |
|  | ceiling-mounted and wall-mounted |  | illuminate tilted |  | rechargeable battery powered |
|  | wall-mounted |  | color of suspension cable |  | fixture with natural vivid LED (upon request) |
|  | omni-directional light distribution |  | length of suspension cable |  | color rendering index |
|  | direct light distribution |  | reflector degree selection |  | color temperature |
|  | direct/indirect light distribution |  | super spot |  | lumen (luminous flux) |
|  | indirect light distribution |  | lens |  | efficacy (lumens per watt) |
|  | asymmetric light distribution |  | lens pack |  | Unified Glare Rating (UGR) range from 5-40 |
|  | aura light distribution |  | shine ring |  | marine grade (AISI 316 stainless steel) |
|  | round wall or ceiling cut-out |  | integrated shine ring with diffuser |  | walk on |
|  | square wall or ceiling cut-out |  | free individual colors 01-29 |  | drive on |
|  | the supplied jig specifies the cutout dimensions |  | individual colors: 00 (free of charge), 01-25 (extra charge) |  | Dark Sky Compliance |
|  | minimum distance (meters) lamp - object |  | luminaire part to be colored (F1) |  | Americans with Disabilities Act (less than 4" off the wall located between 27"-84" from floor) |
|  | recessed depth |  | luminaire part to be colored (F2) |  | lamp protected against explosion |
|  | ceiling thickness in mm |  | luminaire part to be colored (F3) |  | blown glass using traditional methods by master glass blower |
|  | ceiling thickness selection |  | luminaire part to be colored (F4) |  | acoustic material |
|  | dimmable DP (phase), DV (0-10V), DD (dali), DS (step-dim) |  | luminaire part to be colored (F5) |  | protection class I, protection insulation |
|  | included or excluded LED driver/transformer/control gear |  | color of 3-circuit adaptor |  | protection class II, protection insulation |
|  | separately switchable |  | indirect diffuser |  | ETL Certified to UL and CSA Standards |
|  | sensor |  | direct diffuser |  | UL Certified to UL and CSA Standards |
|  | remote control |  | ball-proof (upon request) |  | CSA Certified to UL and CSA Standards |
|  | available upon request |  | accessory |  | Certified for North American Standards |

IP RATING

| | |
|---|--|
|  | protected against ingress of solid bodies greater than 12.5mm (finger) |
|  | protected against ingress of solid bodies greater than 2.5mm protected against sprays of water up to 60 degrees from the vertical (rain) |
|  | protected against ingress of solid bodies greater than 1mm (wire) no protection against the ingress of moisture |
|  | protected against ingress of solid bodies greater than 1mm (wire) protected against sprays of water up to 60 degrees from the vertical (rain) |
|  | protected against ingress of solid bodies greater than 1mm (wire) protected against water splashed from all directions |
|  | protected against limited ingress of dust (wet rooms/covered outdoor areas) protected against water splashed from all directions |
|  | protected against ingress of dust protected against jets of water |
|  | protected against ingress of dust protected against powerful jets of water or heavy seas |
|  | protected against ingress of dust protected against immersion of water between 15cm - 1m for 30 minutes |
|  | protected against ingress of dust protected against immersion of water under pressure for long periods |

IK RATING

| | |
|---|---|
|  | protected against 0.14 joules impact (equivalent to 0.25kg mass dropped from 56mm above the surface) |
|  | protected against 0.2 joules impact (equivalent to 0.25kg mass dropped from 80mm above the surface) |
|  | protected against 0.35 joules impact (equivalent to 0.25kg mass dropped from 140mm above the surface) |
|  | protected against 0.5 joules impact (equivalent to 0.25kg mass dropped from 200mm above the surface) |
|  | protected against 0.7 joules impact (equivalent to 0.25kg mass dropped from 280mm above the surface) |
|  | protected against 1 joules impact (equivalent to 0.25kg mass dropped from 400mm above the surface) |
|  | protected against 2 joules impact (equivalent to 0.5kg mass dropped from 400mm above the surface) |
|  | protected against 5 joules impact (equivalent to 1.7kg mass dropped from 300mm above the surface) |
|  | protected against 10 joules impact (equivalent to 5.0kg mass dropped from 200mm above the surface) |
|  | protected against 20 joules impact (equivalent to 5.0kg mass dropped from 400mm above the surface) |